

Article number: 20289B42B42S2BL

Description: E+G Swivel clamp connector - GN 289-B42-B42-S-2-BL

Measures

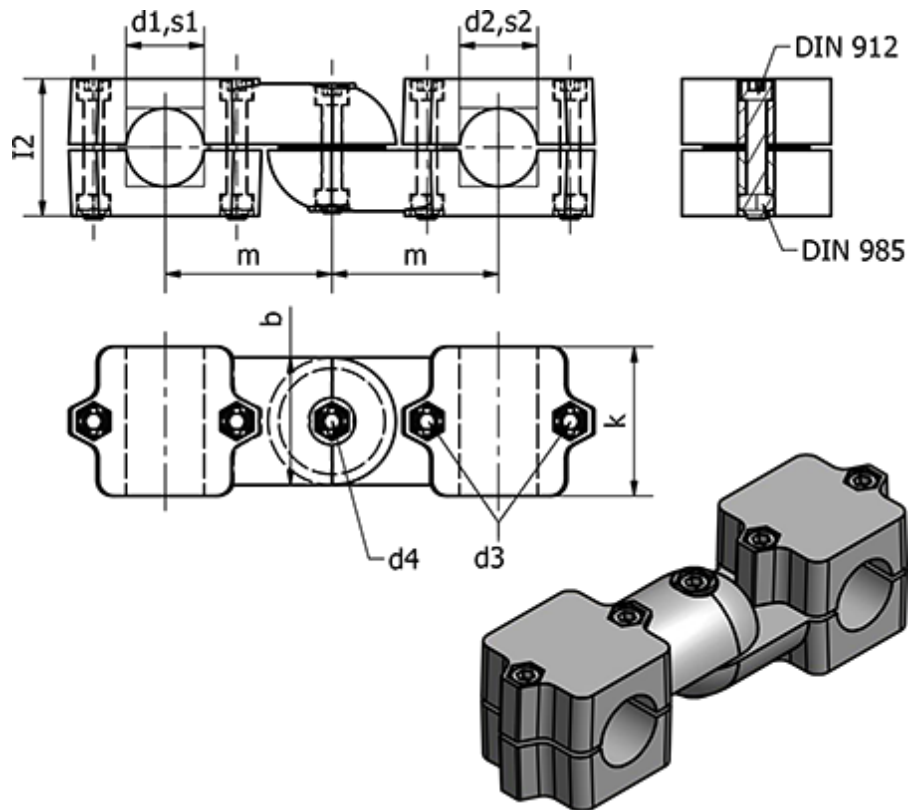

b	= 65	l2	= 70
Clamping kit for d3	= GN 911-M10-55	k	= 76
Clamping kit for d4	= GN 911-M10-63	m	= 85
d1	= B42	s1	= -
d2	= B42	s2	= -
d3	= M10	Weight (g)	= 1724
d4	= M10		
l1	= 268		